



# Wildfire Risk Reduction and Recovery Tips For Homeowners

USDA-NRCS, Tucson, AZ

June 2002

As more homeowners move into rural areas to get away from crowded urban areas, they can unknowingly place themselves in harm's way.

Building homes in wooded and/or brushy areas is aesthetically pleasing, but homeowners need to be aware of the potential dangers from wildfire and how to protect their homesites from wildfires.

Homes that are even far away from a fire can still be impacted. Slopes left denuded by range or forest fires are especially susceptible to accelerated soil erosion, flash flooding, and debris flows because of the absence of vegetation and roots to bind the soil. Homesites near waterways or on slopes that are downstream from a fire could be subjected to the above-mentioned flooding events.

This publication contains some techniques, practices, and information homeowners can use for new or existing homesites to reduce their susceptibility to damage from wildfires and related flooding events.

The Natural Resources Conservation Service (NRCS) and your local conservation district are available to answer your questions and provide assistance as you recover from the aftermath of a wildfire or prepare your homesite to reduce potential damage from a wildfire.

## Prevention

**Step one:** Plan your home site location to reduce the risk of damage caused by wildfires.

Check with local officials regarding the availability of fire protection for your location. Evaluate your site for fire protection equipment accessibility. Place your home on a level area, rather than on a slope. Ensure clear identification of access roads and of your homesite.

Develop a fire escape plan that details escape routes and a meeting location outside the home. Rehearse your plan so all family members know what to do and where to go in an emergency.

**Step two:** Work with your architects, contractors, and local fire officials during construction to create a home that is firewise and aesthetically pleasing.

Use fire resistant roofing and wall materials, and keep flammable vegetation, woodpiles, and other debris at a safe distance from the home and other buildings. If your home has a fireplace, make sure the fireplace is an approved unit and the chimney has noncombustible wire mesh screening. Windows should have thick tempered safety glass. Double pane windows may be appropriate, but contact your local fire officials to determine what is most suitable.

**Step three:** Maintain the landscape and create a defensible space or safety zone around your home.

This zone can be created by selecting fire resistant landscape plants and by mowing or clipping the herbaceous vegetation at least 30 feet around your home to a 3-4 inch height. Waiting to mow until the plants have set seed (early or mid-summer to fall) will help maintain the vigor of your grasses and forbs. Mowing around trees and shrubs, up to and beyond 100 feet, will create mulch to help reduce soil erosion and reduce a fire's ability to climb into trees and brush.

As the slope of your lot increases, you may need to extend your safety zone beyond 100 feet. Consult with local fire officials on the creation and maintenance of your safety zone.

Clean roofs, gutters, and eaves regularly. Stack firewood away from the house and other buildings.

### Contents

<b>Vegetative Practices</b>	<b>Page no.</b>	<b>Structural Practices</b>	<b>Page no.</b>
Seed Specifications	2	Jute Netting	7
What are Hydrophobic Soil	3	Sandbag Protection	9
Hazards from Debris Flows	4	Silt Fence	11
Hydroseeding/Hydromulching	5	Straw Bale Check Dams	13
		Straw Bale Dikes	15
		Straw Mulching	17
		Burlap Bag Check Dams	19

## Recovery

Vegetation is one of the most important factors influencing soil erosion. It helps control erosion by shielding the soil from the impact of raindrops, maintaining a soil surface capable of absorbing water, and slowing the amount and velocity of runoff.

There is a good chance that native seeds on your property are still alive and will germinate. Old and new vegetation will help protect the soil from erosive rains. In severely burned areas, seeding may be required.

Your first step is to field check the burned area and map out areas that have burned intensively and, thus, may have very little seed under the ash.

White ash shows where the fire was very hot and seeds were most likely destroyed. Burned areas that had thick brush, without a grass understory, will not have enough seed.

For large fires on federal lands, seed survey teams examine areas as soon as possible, and before significant rainfall events, to confirm which parts of the potential treatment area do not have an adequate amount of viable seed. They establish transects across the treatment area and collect one square foot of the soil surface to a one-inch depth at five points along the transect. The soil samples are then placed in shallow propagation flats, placed in a greenhouse, and lightly irrigated for 10 days. The seedlings present in 10 days provide an indication of seed viability per square foot of soil and how much viable seed is immediately available for erosion control when the first rain occurs.

Desirable seeds are grasses and forbs. The minimum amount to seed is an aggregate of 25 viable seeds per square foot when drill seeded and 50 viable seeds per square foot when broadcast seeded.

Exposed earth areas such as new roads, firebreaks, and steep embankments, including cut and fill slopes, should also be planted.

## Species Selection

Contact your local NRCS field office or Plant Materials Center for a suggested list of species that are adapted to your specific area. The phone number of the nearest field office can be found in the Federal Government Offices White Pages of your phone directory. Look under United States Department of Agricultural or Natural Resources. Field offices can be found under "Natural Resources Conservation Information and Technical Assistance."

Additional information regarding NRCS, the Plant Materials Program, and requesting assistance

from NRCS can be obtained at: <http://nrcs.usda.gov> or <http://Plant-Materials.nrcs.usda.gov>.

## Methods of Seeding

Seeds can be broadcast by hand, with a hand-operated seeder, hydroseeder, drilled, or air seeded.

Most homeowners and small landowners will find broadcasting to be the most economical method. Hydroseeding requires roads for equipment access and a nearby water supply. Use drill seeding when possible or aerial seeding on large acreages.

## Seed Specifications

The total amount of seed purchased should equal the acres burned multiplied by the recommended seeding rate per acre. Include any roads and firebreaks in the burned acreage.

If the seed is coated by the supplier or is less than 80% Pure Live Seed (PLS), then adjust the amount of seed purchased. Check seed tags for each species to determine the percent germination and purity.  $PLS = \% \text{ germination} \times \% \text{ purity}$ .

Obtain seed supplies of each species in separate bags and keep cool and dry.

## Low PLS Adjustment

Example: When the recommended seeding rate is **10 pounds per acre** and your seed has a 90% purity and a 70% germination rate, then your PLS =  $(90\% \times 70\%)$  63% PLS. Since the PLS is less than the recommended 80%, you need to adjust your seeding rate. An adjustment factor is calculated by dividing the suggested PLS (80%) by your actual PLS (63%). In this example, the adjustment factor is 1.3  $(80 \div 63 = 1.3)$ . To calculate your actual seeding rate multiply the adjustment factor by the recommended seeding rate  $(1.3 \times 10 \text{ lbs/acre} =$  **13 pounds per acre**).

If the supplier coats the seed with inoculant, then the seeding rate for the coated seed should be adjusted. No adjustment is needed when you inoculate alfalfa (alfalfa is an example species and may not be recommended in your mix) or other legume seeds.

Recommended seeding rates are based on uncoated seed and need to be adjusted, as shown in the following example, after making any adjustment for low PLS.

**Example:** Coated alfalfa seed or other small seeded legumes with a suggested seeding rate of 6 pounds per acre. The adjustment factor = 1.5 and the adjusted seeding rate is  $(1.5 \times 6 \text{ lbs/acre})$  **9 lbs/acre**.

## Equipment and Materials Needed

Equipment and materials should be ready before you start. This list of items will minimize disruptions and let you finish seeding in one day for small areas.

- 1 hand operated cyclone seeder for each person doing the seeding
- Weight scale, at least 20-pound capacity
- At least 2 plastic buckets
- Seed targets. At least 2 pieces of 2x2-foot soft cloth or cardboard with corrugations exposed, nailed to a small wood frame, or at least 4 pieces of 1x1-foot soft cloth attached to an open wire frame
- 4 paper grocery bags and 2 marker pens
- Inoculant. Specific type for each legume. Omit if supplier coats seed.

## Getting Started

Inoculating legumes enables them to “fix” nitrogen that improves the health of the plant and provides additional fertility for other plants.

Inoculate alfalfa and other legume seeds (if the supplier has not) the evening before or early on seeding day so the seed will dry by seeding time. Re-inoculate seed coated over 30 days ago or seed that has not been kept cool and dry.

## Seeding Specifications

Divide seed of each species into equal amounts and label bags. Keep cool and dry. When seeding a mixture, broadcast each species separately, if possible, to get good uniform seed distribution.

Adjust the seeder according to the manufacturer’s instructions based on half the seeding rate when seeding in arid areas. Base it on the full seeding rate when doing a simple once-over seeding. Set out two seed targets 10 feet apart and offset 10 feet. With the hand-operated seeder half full, start broadcasting and walk between the two seed targets. Stop and check the seed count at each target. Adjust the seeder and repeat until the number of seeds per square foot agrees with your approximate target of 50 minimum seeds per square foot.

Broadcast in two directions to achieve a uniform distribution of seed. Use half the seed of a given species; broadcast the seed as you walk across the slope, starting at the top of the burn area. Notice how far the seed is thrown. When you reach the other edge of the burn area, move downslope a distance equal to the width of throw.

Continue broadcasting and walk back across the slope, trying to avoid gaps. Repeat this process all the way to the bottom edge. When several people are

seeding, move across the slope together. Adjust your walking pace so you have enough seed to finish.

Using the remaining half of the seed, repeat the procedure going up and downslope. However, on steep slopes, it is best to broadcast only walking downslope because you need to maintain the same walking speed used to calibrate the seeder. Using several people will make this easier.

Broadcast in one direction if conditions do not allow seeding in two directions. Broadcast the remaining seed in the same direction across the slope while walking midway between your previous lines of travel.

Repeat the above process for each species.

## What are Hydrophobic Soils?

**Definition:** Wildfires burn dead and living vegetation that accumulates on the soil surface. Burning produces volatile hydrophobic substances that can penetrate the soil up to a depth of six inches. When these substances penetrate the cool soil, they condense and coat the soil particles, making the soil hydrophobic or water repellent.

Soils that are water repellent exhibit a decreased water infiltration rate and an increased water runoff rate, creating extreme soil erosion potential.

Initially, rain or irrigation water will run off hydrophobic soils instead of infiltrating and promoting germination of seed and growth of roots. This makes it difficult to establish a stand of vegetation.

Water repellent soils will be the worst where vegetation was thickest and burn temperatures were extreme, especially under trees, thick brush and around buildings that burned to the ground.

## Field Check

Field check for water repellent soil conditions by digging a shallow trench with a vertical wall and applying water droplets from the surface down in 1-centimeter increments.

- If water sits as a ball on the soil for 10-to-40 seconds, it is moderately hydrophobic.
- If more than 40 seconds, it is strongly hydrophobic.

## Treatment

On gentle slopes, chisel the soil a few inches deep, perpendicular to the slope, to break up the hydrophobic layer. This will allow water to penetrate the soil surface for seed germination and root growth.

On steeper slopes, lightly spray the soil surface with a soil wetting product (surfactant). This will break up the hydrophobic substances coating the soil particles the way dishwashing detergent breaks up grease. Then water can penetrate the soil readily. Soil wetting products can be purchased at lawn and garden stores.

## Hazards from Debris Flows

Debris flows are shallow landslides, saturated with water that travel rapidly downslope as muddy slurries, carrying rocks and debris.

Even moderate precipitation can cause major flooding on a wildfire damaged watershed due to the lack of vegetation and roots to bind the soil. Areas directly downslope are especially subject to damage.

**What can be done to avoid or reduce the hazard of debris flows?** To be safe, assume that all drainages in steep, hilly areas are capable of carrying debris flows and are especially vulnerable after a wildfire.

**Avoid building at the bottoms and mouths of steep ravines and drainage courses.** These areas are the most likely to be inundated. The outer banks of bends along such ravines should also be avoided, because swiftly flowing debris avalanches can “ride” up and out of the stream channel.

**Avoid building on or below steep slopes.** In general, the steeper the slope, the greater the risk. If these areas must be used, consult with a soil engineer and engineering geologist. They will be able to evaluate the potential for problems and give advice on the best way to minimize the risk to life and property.

**Limit the height and slope of cuts and fills in human-modified slope cuts.** Properly compact fills, key them into bedrock, and properly control the flow of water onto slopes.

**Stay alert to the amount of rain falling in your area during rainstorms.** Concerns for flooding and debris flows are based on moderate to high amounts of moisture over short periods. Minimal precipitation rates, especially after previous storms, could possibly trigger flooding and debris movement events.

## For Additional Information

For additional information on wildfire risk reduction, please visit the following websites:

<http://www.firewse.org>  
<http://www.usfa.fema.gov/wildfire/>  
<http://www.extension.unr.edu/FIRE/FrontPage.html>  
<http://www.psw.fs.fed.us>

Fact sheets and other additional information regarding specific practices and or wildfire related hazards can be found at:

<http://www.ca.nrcs.usda.gov/pa/ewp.html>.  
<http://www.mt.nrcs.usda.gov/pas/fires/firemt.html>.

Additional information regarding floods, debris flows, and erosion control can be found at:

<http://ladpw.org/pln/HomeOwners/index.cfm>  
<http://www.consrv.ca.gov/dmg/pubs/notes/33/index.htm>.

This brochure adapted from “*Wildfire Recovery Tips*” brochure, produced by USDA-NRCS, Boise, Idaho, July 2000.

Bruce Munda  
Arizona Plant Materials Specialist  
Tucson, AZ

June 2002

The U.S. Department of Agriculture (USDA) prohibits discrimination in all its programs and activities on the basis of race, color, national origin, sex, religion, age, disability, political beliefs, sexual orientation, or marital or family status. (Not all prohibited bases apply to all programs.) Persons with disabilities who require alternative means for communication of program information (Braille, large print, audiotape, etc.) should contact USDA’s TARGET Center at (202) 720-2600 (voice and TDD).

To file a complaint of discrimination, write USDA, Director, Office of Civil Rights, Room 326-W, Whitten Building, 1400 Independence Avenue, SW, Washington, D.C. 20250-9410 or call (202) 720-5964 (voice and TDD). USDA is an equal opportunity provider and employer.

## Hydroseeding and Hydromulching

The terms hydroseeding and hydromulching are often used interchangeably.

- **Hydroseeding** is applying a slurry of water, wood fiber mulch, seed, and fertilizer to the soil surface to prevent soil erosion and provide an environment conducive to plant growth.
- **Hydromulching** is applying a slurry of water, wood fiber mulch, and often a tackifier to a slope to prevent soil erosion.

## When to Use

**General recommendation:** On steep, highly erosive slopes that have been partially or completely denuded of vegetation due to fire, apply seed to the site first and then hydromulch over the seed to keep the seed from washing off the slope.

This is a fairly expensive erosion control method that is often reserved for areas close to roads, bridges, homes, and other structures. Use is sometimes restricted due to lack of access roads and adequate water supplies. Slope lengths of 125-225 feet can be treated.

For small landowners, this technique will need to be hired out. Check the listings under “Landscape contractors,” “Erosion Control,” or “Seeding Contractors” in the yellow pages of your telephone directory.

## Hydroseeding and Hydromulching

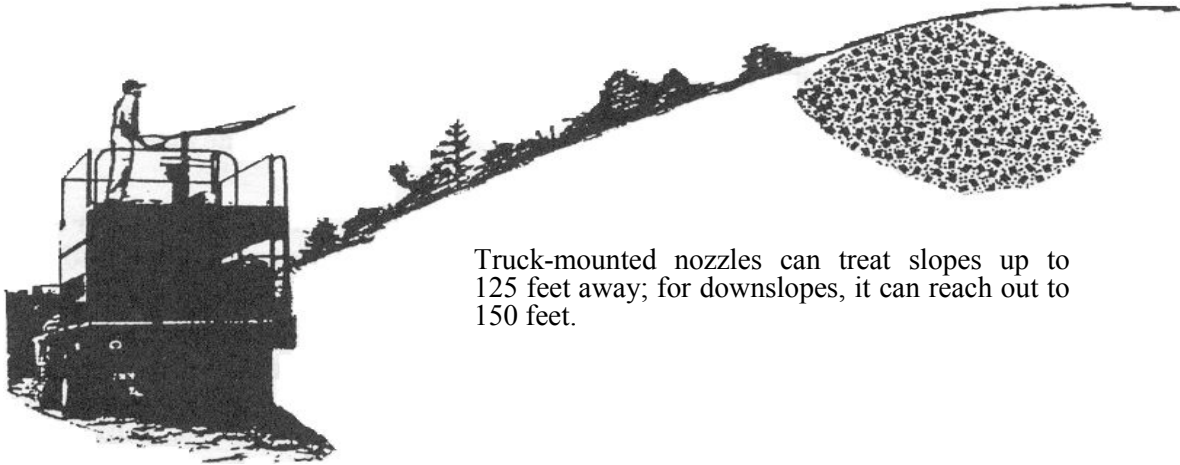

Truck-mounted nozzles can treat slopes up to 125 feet away; for downslopes, it can reach out to 150 feet.

**Hydromulching:** Tank mix includes water, wood fiber, and tackifier (optional).

**Hydroseeding:** Tank mix includes water, wood fiber, seed, fertilizer, (optional after fire) and tackifier (also optional). General recommendation: Apply seed to site first then hydromulch on top of seeding.

200 to 225 feet of slope can be treated by first using 100 to 150 feet of hose pressurized by the tank truck

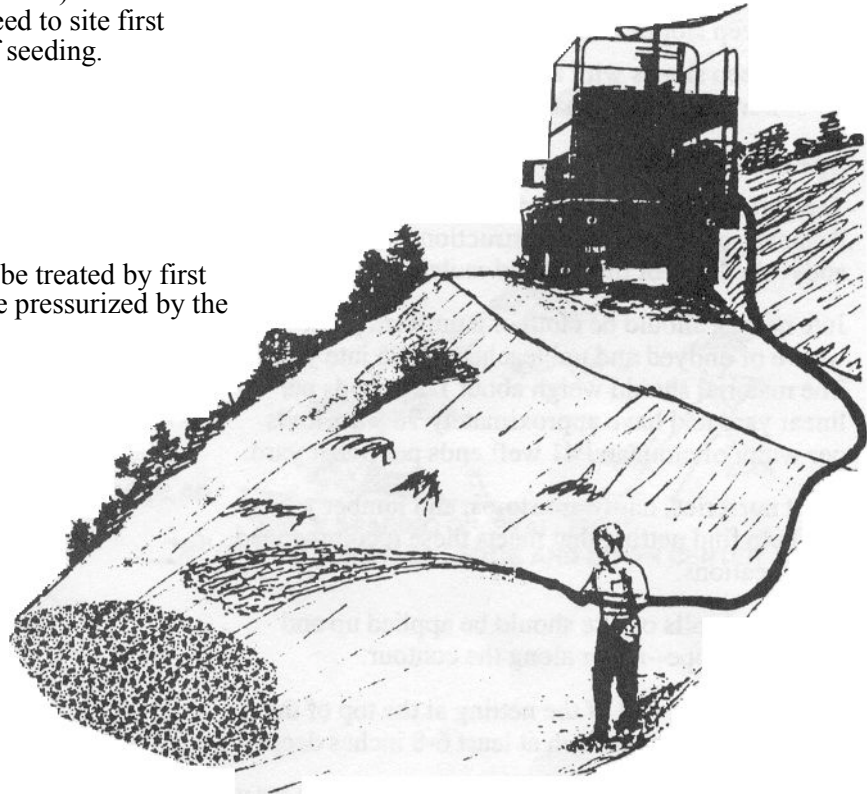

## Jute Netting

Netting made of jute can be laid and anchored over straw or other mulch to help protect the soil from wind and water damage. Netting helps reduce soil erosion and provides a good environment for vegetative regrowth.

Jute is a biodegradable material that will eventually decompose and is not a threat to the environment or wildlife.

### When to Use

Jute netting can be used on areas that may erode near structures such as homes, roads, and bridges or on small, steep, disturbed areas.

Netting can also be applied alone (without mulch) as an alternative to straw or wood mulches on flat sites for dust control and seed germination enhancement.

It should not be used alone where runoff quantities are expected to be high.

The use of jute netting is not appropriate in all situations. Examples of when it may not be appropriate:

- Steep slopes with sandy soils
- Steep slopes with many rocks on the surface
- Steep slopes with a significant amount of fire burned vegetation remaining
- 

### Specifications

The soil surface should be reasonably smooth. Remove rocks and other obstructions that rise above the level of the soil or mulch.

Jute netting should be cloth of a uniform plain weave of undyed and unbleached single jute yarn. The materials should weigh about 1.2 pounds per linear yard and have approximately 78 warp ends per width of cloth and 41 weft ends per linear yard.

Most nurseries, hardware stores, and lumber yards can help find netting that meets these recommended specifications.

Individual rolls of jute should be applied up and down the slope--never along the contour.

Bury the upper end of the netting at the top of the disturbed area in a trench at least 6-8 inches deep.

Lay out rolls so edges overlap each other by at least 4 inches.

**Extremely important:** When more than one roll is required going down slope, the ends going down the slope should overlap by at least 3 feet.

Anchor the netting to the soil surface with anchor pins or staples. Anchor pins are made of rigid 0.12-inch diameter or heavier galvanized wire with a minimum length of 10 inches for hook or "J" type pins. Staples should be of wire .09 inch in diameter or greater and should have "U" shaped legs that are at least 6 inches long. Longer staples are needed for sandy soils.

Staples or anchor pins need to be driven perpendicular into the slope face and should be spaced about 5 feet apart down the sides and center of the roll.

Spacing between staples at the upper end of a roll and at the end overlap of 2 rolls should not be greater than 1 foot.

The netting should go beyond the edge of the mulched or seeded area at least 1 foot at the sides and 3 feet at the bottom. If there is vegetation at the boundaries of the area, the netting should be continued into the stable vegetated area or to the edge of a structure.

# Jute Netting

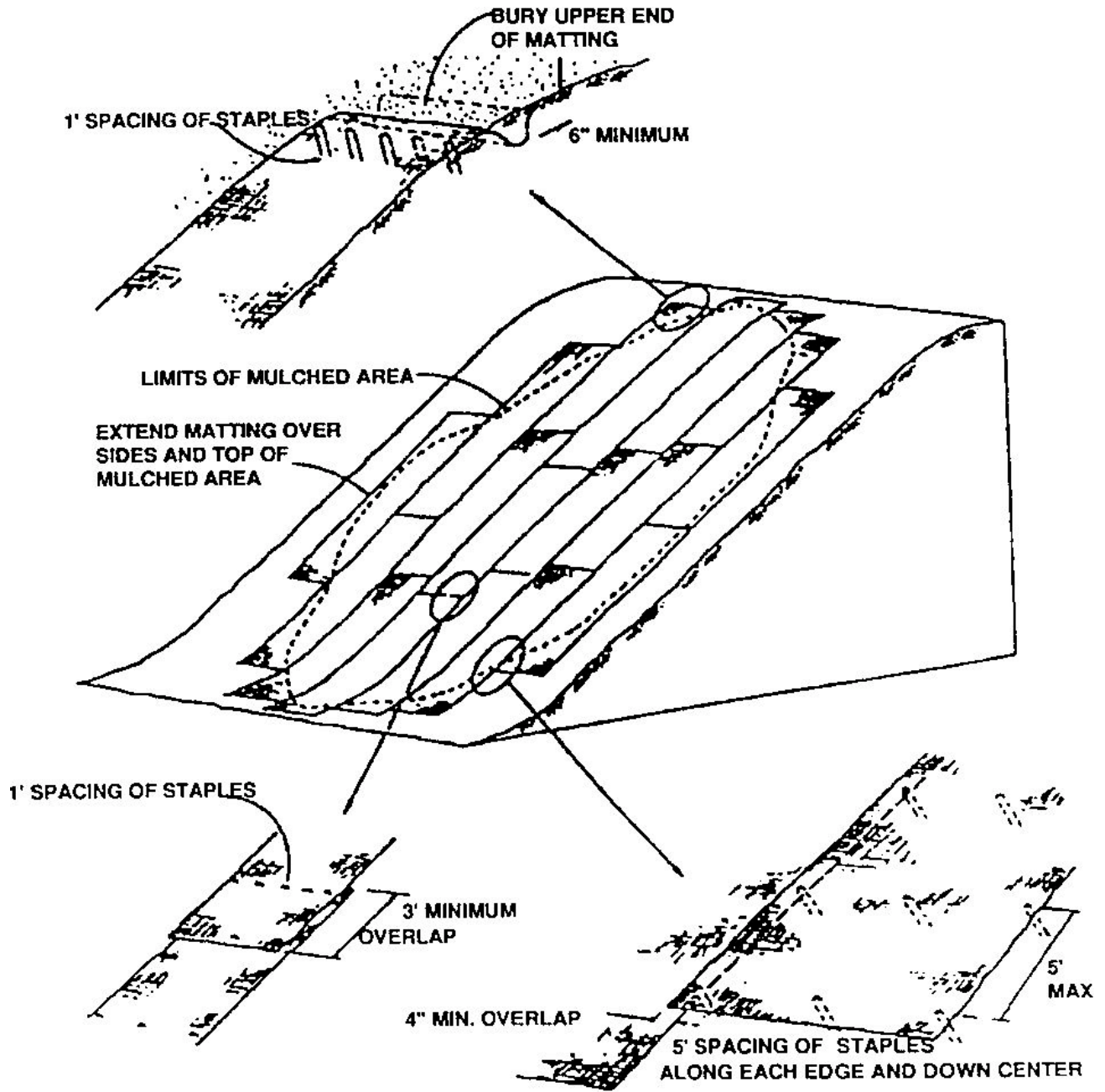



## Sandbag Protection

An inexpensive temporary barrier or wall, 1 to 2 feet high, can be constructed by stacking sand-filled or earth-filled sandbags. They can be placed to divert mud and other debris flows away from buildings. They will not, however, provide protection from high debris flows.

### When to Use

- To protect building sites vulnerable to low mud debris flows from steep, erodible slopes that are partially or completely void of vegetation due to wildfire burns.
- As an inexpensive, temporary protection method for home before predicted rainfall.

**Note:** Sandbags deteriorate when exposed to continued wetting and drying for several months. If the bags need to be used for more than a few months, cement can be mixed with the sand. The cement and sand mixture will harden when the bags dry.

### Methods and Materials

Sandbag barriers are easy to construct. Burlap bags, sand, plastic, lumber, cement and plywood are readily available at local lumberyards. Some fire stations and other emergency centers can also help with materials.

Place filled sandbags to direct debris flows away from buildings, pools, and other structures. Clear a path for the debris. Do not try to dam or stop debris flows.

Protect your most valuable property first. Debris can enter a building through doors and windows, so they should be boarded up and waterproofed with plastic sheets. **Remember:** Sandbags will not seal out water.

Work with your neighbors and be prepared to use your property to provide good protection for the community.

### How to Fill Bags

Fill sandbags one-half full. Use sand, if available, or, local soil. Fold the top of the sandbag down and place the bag on its folded top (see illustration).

### How to Place Bags

Refer to illustration. Place each sandbag as shown finishing each layer before starting the next. Limit placement to two layers unless they are stacked against a building or pyramided.

It is important to place bags with the folded top in the upstream or uphill direction facing the flow of water to prevent them from opening when water runs by.

# Sandbag Protection

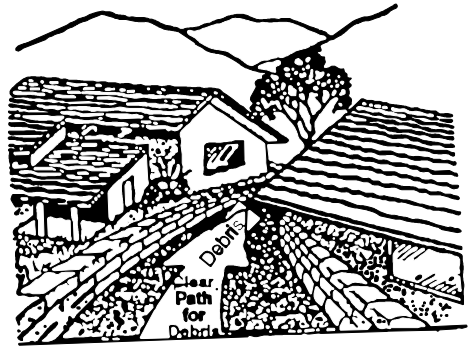
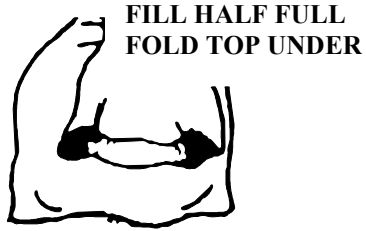

Sliding glass door sealing

Directing flows between buildings

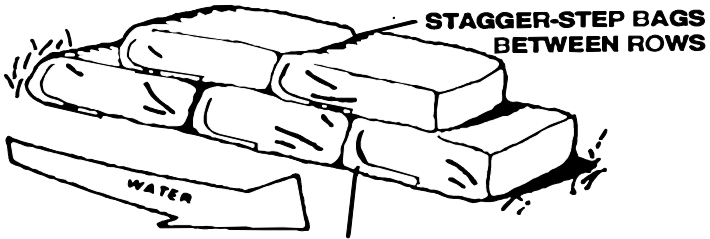

PLACE BAG WITH FLAP UNDER BAG

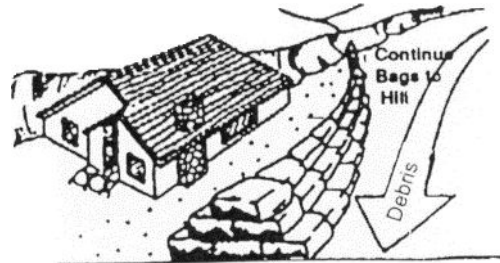

Directing debris away from buildings

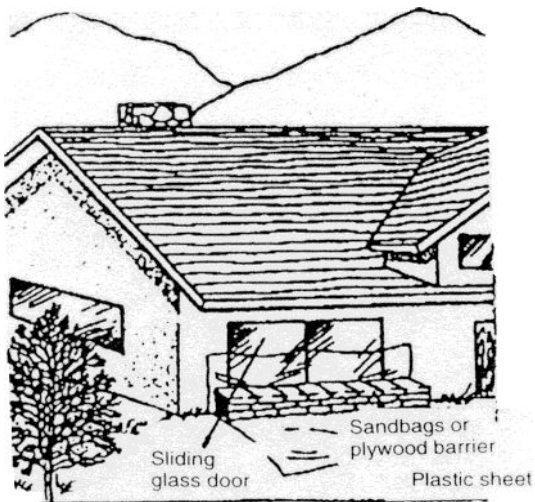
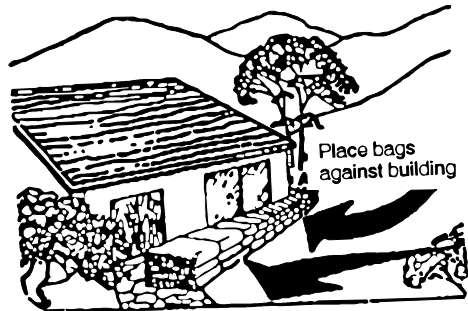
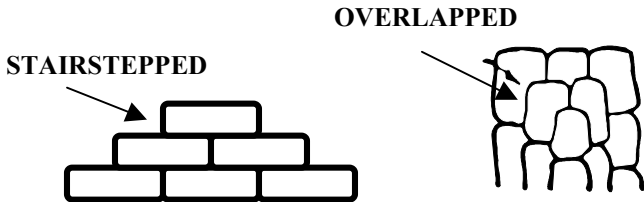

Sliding glass door sealing

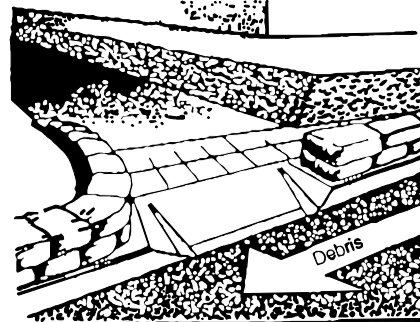

Controlling debris/storm flows in streets

## Silt Fence

A silt fence made of woven wire and fabric filter cloth is a temporary barrier that can be used to catch sediment-laden runoff from small areas of disturbed soil.

Silt fences are easy to construct. Materials are available from hardware stores, nurseries, and lumber yards.

## When to Use

Major considerations for use of silt fences are slope, slope length, and the amount of drainage area from which the fence will catch runoff.

Here are some design considerations:

<u>Slope Steepness</u>	<u>Maximum Slope Length</u>
2:1 = 50%	50 feet
3:1 = 33%	75 feet
4:1 = 25%	125 feet
5:1 = 20%	175 feet
<5:1 = <20%	200 feet

For longer slopes, add additional silt fences.

## Drainage Area

The area that contributes runoff to be caught by the silt fence should not be greater than .5 acre for every 100 feet of fence.

## Type of Runoff

Silt fences are designed to catch runoff that is in the form of “sheet flow,” not “concentrated flow.”

Sheet flow differs from concentrated flow in that the runoff is spread evenly over the ground surface, like a sheet, rather than concentrated in small rills or gullies.

## Methods and Materials

**Fence Posts:** Posts should be at least 36 inches long. Wood posts should be of hardwood with a minimum cross sectional area of 3 inches. Steel posts should be standard “T” or “U” section and should weigh no less than 1 pound per linear foot.

**Wire:** Wire fence should be at least 14 gauge with openings no larger than 6x6 inches.

**Extremely Important:** Bury the fence at least 8 inches below ground level and install the fence following the contour (perpendicular to the slope).

Silt Fences are not permanent structures and **must** be maintained and/or inspected on a regular basis. Debris that is trapped behind the fence should be removed when the fence shows signs of bulges.

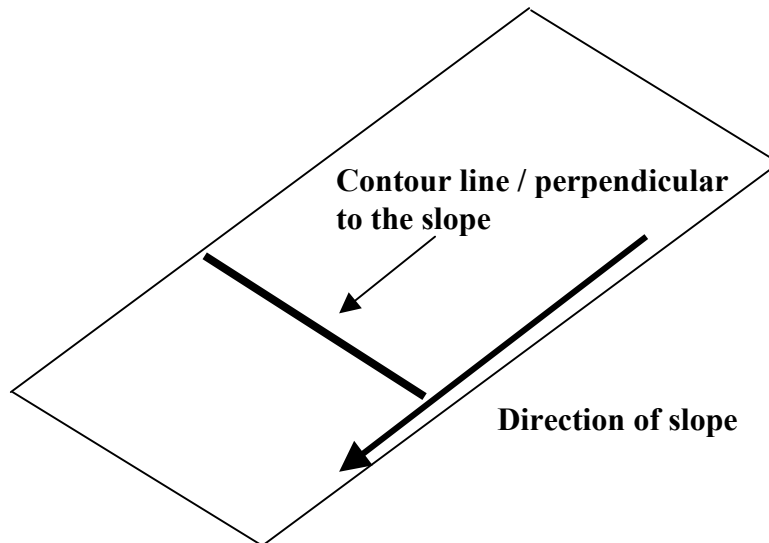

# Silt Fence

## Fabric Properties:

Filter fabric properties should be as follows (hardware store personnel can help you with these):

Fabric Property	Minimum Acceptable Value	Test Method
Grab tensile strength (LBS)	90	ASTM D1682
Elongation at Failure (%)	50	ASTM D1682
Mullen Burst Strength (PSI)	190	ASTM D3786
Puncture Strength (lbs)	40	ASTM D751 (mod)
Slurry flow Rate (gal./min/sf)	0.3	
Equivalent Opening Size	40-80	US Std Sieve
Ultraviolet Rad. Stability	90	ASTM-G-26

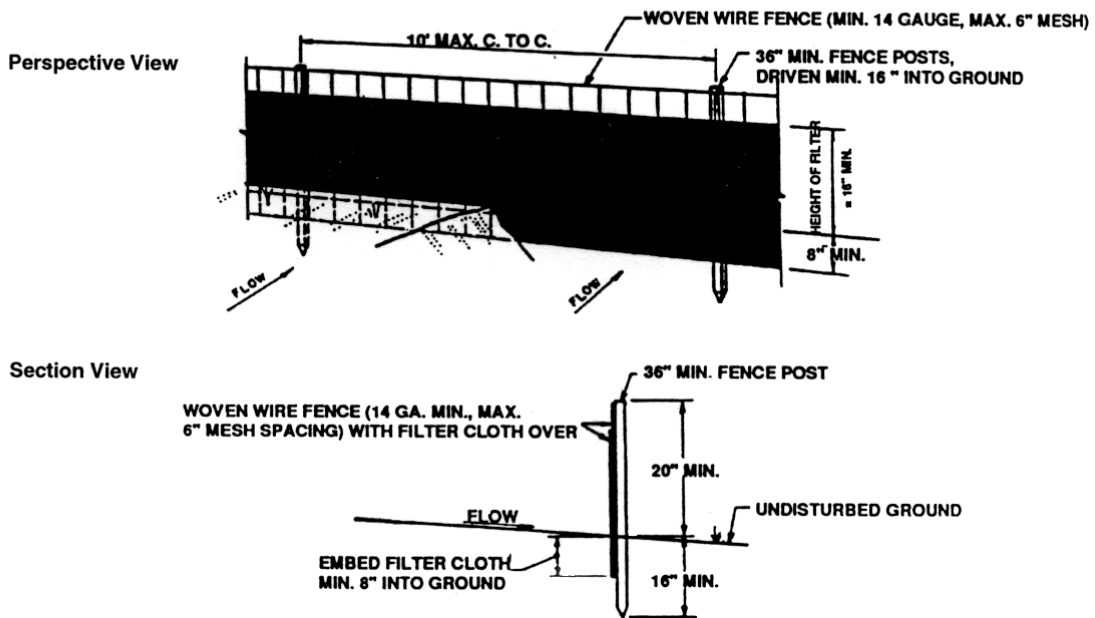

## Construction Notes

1. Woven wire fence to be fastened securely to fence posts with wire ties or staples.
2. Filter cloth to be fastened securely to woven wire fence with ties spaced every 24" at top and midsection.
3. When 2 sections of filter cloth adjoin each other, they shall be overlapped by 6" and folded.
4. Maintenance shall be performed as needed and material removed when "bulges" develop in the silt fence.

## Straw Bale Check Dams

Straw bale check dams are temporary sediment barriers constructed of straw bales located across small drainages. They are temporary structures used to slow debris flows in small channels. They are not intended to provide protections from large storm events nor to control debris flows in water bodies such as creeks, streams, or rivers.

### Planning Criteria

0-15% slope:

Maximum drainage area: 1 acre

Maximum slope length between check dams:  
200 feet

15 – 20% slope:

Maximum drain area: .5 acre

Maximum slope length between check dams:  
100 feet

Greater than 20% slope

Not recommended

### Methods and Materials

Bales should be bound with wire or nylon string. Jute twine bound bales are less durable. Place the bales in rows with ends tightly abutting adjacent bales. Bales should be made from clean weed free straw.

**Downstream Row** (see illustration): Dig a trench across the small channel, wide enough and deep enough so the top of the row of bales placed on their long wide side is level with the ground.

The tops of bales across the center of the channel should all be level and set at the same

elevation. Place the bales in position and stake them according to the instructions that follow.

**Upstream Row:** Dig another trench across the small channel, upstream and immediately adjacent to the first row of bales. This trench should be wide enough to accommodate a row of bales set vertically on their long edge. It should be deep enough so that at least 6 inches of each bale is below ground, starting with the bale in the channel bottom.

The trench should be as level as possible so the tops of the bales across the center of the channel are level and water can flow evenly across them.

Continue this trench up the side slopes of the small channel to a point where the unburied bottom line of highest bale (point “C” in illustration) is higher than the top of the bales that are in the center of the channel (point “D” in illustration).

### Staking

Drive 2x2 stakes or #4 rebar through the bales and into the ground 1.5 to 2 feet for anchorage. The first stake in each bale should be driven toward a previously laid bale to force the bales together (see illustration).

### Maintenance

Inspect bale check dams after each storm period. Shovel work may be needed to rebuild the soil berm on the upstream side. Remove any loose straw so it does not enter storm drains.

Remove the bales and stakes once vegetation, permanent drainage ways, and stabilization are re-established. Use the straw as mulch in other areas.

# Straw Bale Check Dams

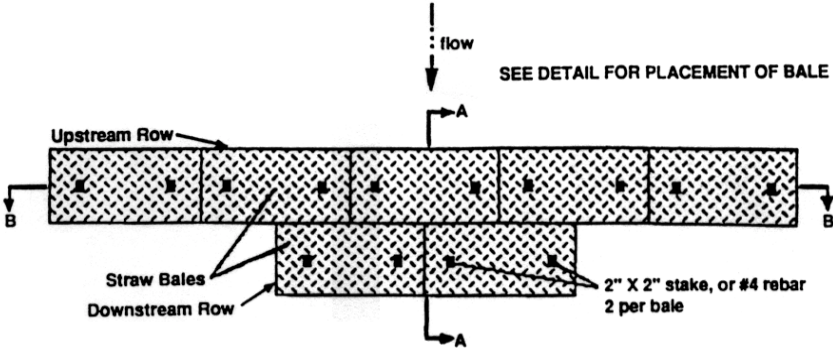

Section A-A

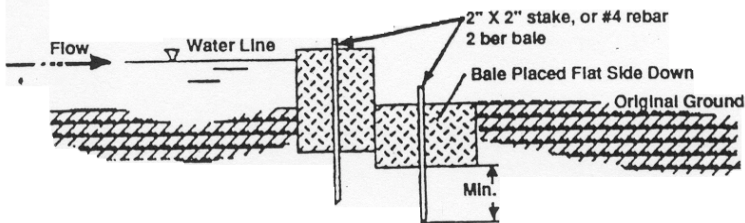

PLACEMENT DETAIL  
UPSTREAM ROW

Remove #4 rebar after  
straw bales are no longer  
in place

Section B-B

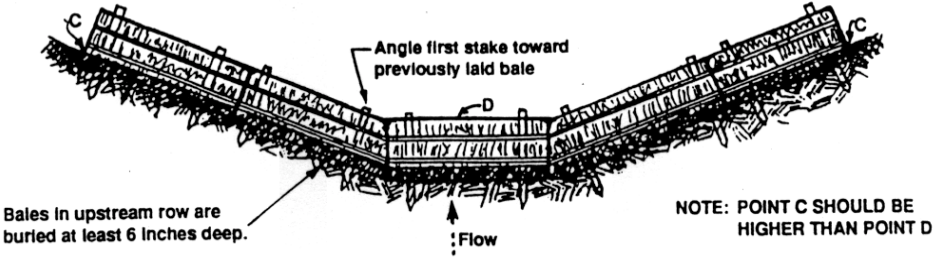

## Straw Bale Dikes

Straw bale dikes are a temporary sediment barrier constructed of straw bales located downslope of a disturbed area or around a storm drainage outlet to redirect debris flows or trap debris materials.

They are usually installed in areas requiring protection from sedimentation expected from predicted rainfall events that will cause erosion.

They are intended to provide protection for a limited time, usually less than 3 months.

### Installation Tips

Drainage area limits:

- **0-15% slope:** Maximum drainage area is 1 acre and maximum slope length is 200 feet.
- **More than 15% slope:** Maximum drainage area is ½ acre, maximum slope length is 100 feet.

Bind bales with wire or nylon twine (jute twine-bound bales are less durable). Bales should be made from clean weed free straw. Place bales in a row with

ends tightly abutting adjacent bales. Do not place bales with wire or twine touching—see illustration. Compress some loose straw between adjacent bales to close voids. The tops of bales should all be level and set at the same direction.

### Staking

Each bale should be embedded in the soil a minimum of 4 inches. Drive 2x2 stakes or rebar through the bales and into the ground 1.5 to 2 feet for anchorage. The first stake in each bale should be driven toward a previously laid bale to force the bales together—see illustration.

### Maintenance

Inspect dikes and provide necessary maintenance following each storm event. It is important to ensure that loose straw does not enter storm drain facilities. Remove bales once permanent drainage and stabilization are re-established. Use the straw as mulch in other areas.

# Straw Bale Dikes

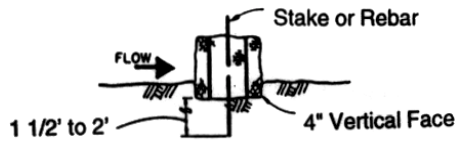

**EMBEDDING DETAIL**  
N.T.S.

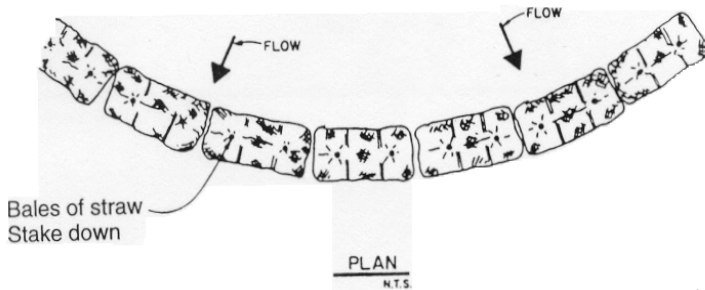

**ELEVATION**  
N.T.S.

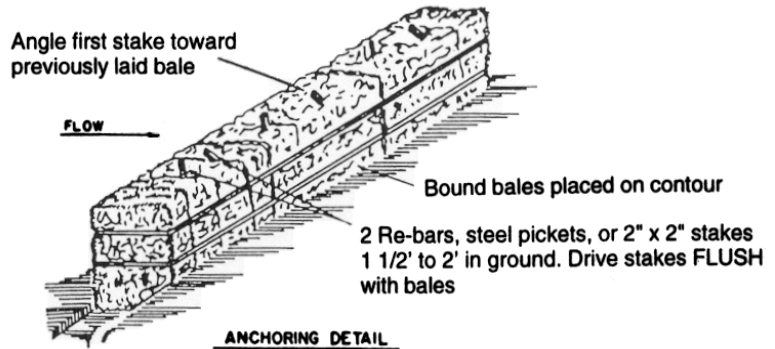
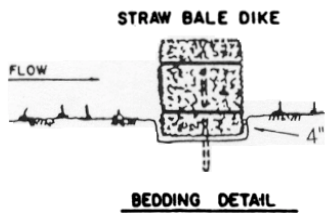



## Straw Mulching

Straw mulching should be used on slopes that have been seeded and have high potential for erosion. It will provide a protective cover to reduce erosion, increase water infiltration, and aid in revegetation.

Mulching requires some type of anchoring by matting, crimping, or other methods to prevent the straw from blowing or washing away.

Straw mulch forms a loose layer when applied over a loose soil surface. To protect the mulch from wind drifting or being moved by water, it must be covered with netting such as jute, punched into the soil with a spade, roller, or mulch tucker, or sprayed with a tacking agent.

Straw mulch should cover the entire seed or bare area and extend into existing vegetation or be stabilized on all sides to prevent wind or water damage which may start at the edges.

## Methods and Materials

On gentle to moderate slopes, straw mulch can be applied by hand broadcasting to a uniform depth of 2-3 inches. On steep slopes, the straw should be blown onto the slope to achieve the same degree of cover.

When applied properly, about 5 to 10% of the original ground surface can be seen. The application rate per acre should be about 2 tons, or one 74-pound bale per 800 square feet. Straw should be clean weed free barley or wheat straw.

## Anchoring

**Hand Punching:** Use a spade or shovel to punch straw into the slope until all areas have straw standing perpendicularly to the slope and embedded at least 4 inches into the slope. It should be punched about 12 inches apart.

**Roller Punching:** A roller equipped with straight studs not less than 6 inches long, from 4-6 inches wide and about 1-inch thick, is rolled over the slope.

**Crimper Punching:** Like roller punching, the crimper has serrated dish blades 4-8 inches apart that force straw mulch into the soil. Crimping should be done in two directions with the final pass across the slope.

**Matting:** Use on large, steep areas that cannot be punched with a roller or by hand. Jute, wood excelsior, or plastic netting can be applied over unpunched straw.

# Straw Mulching

## SPREAD THE STRAW

MARK OFF 800 SQ. FT. PLOTS

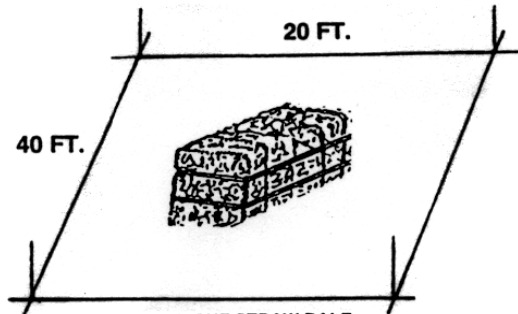

PLACE ONE STRAW BALE PER PLOT (~74 POUNDS). THIS IS EQUIVALENT TO 2 TONS PER ACRE.

SPREAD EVENLY

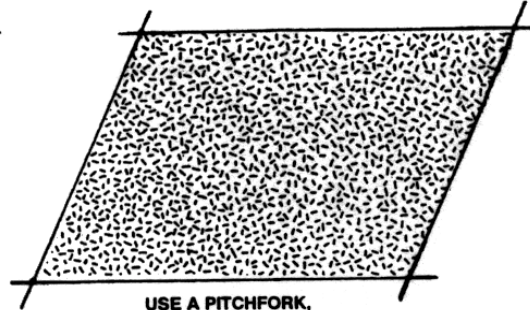

USE A PITCHFORK, SPADING FORK, OR BY HAND

## ANCHOR THE STRAW

CRIMP BY HAND

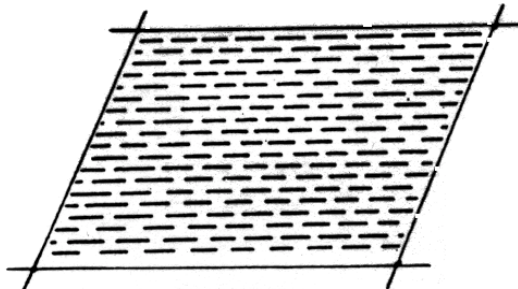

WORK ACROSS THE SLOPE. PUNCH STRAW 4 INCHES DEEP. A SQUARE END SPADE WORKS WELL. MAKE PUNCH EVERY 12 INCHES.

OR

USE PLASTIC NETTING

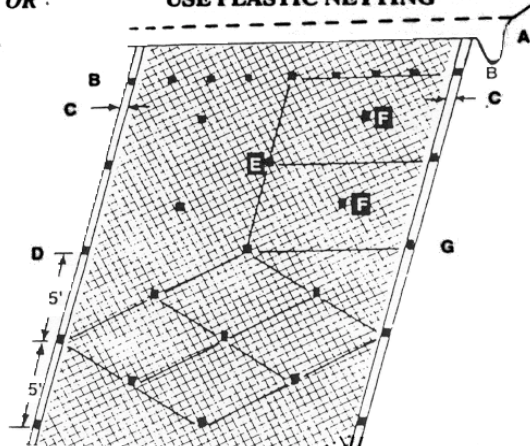

### Construction Notes

1. Lay matting in strips down the slope over the straw. Bury upper end in 6-8 inch deep and wide trench. Most netting comes in 14-17 feet wide rolls.
2. Secure the upper end with stakes every 2 feet.
3. Overlap seams on each side 4-5 inches.
4. Secure seams with stakes every 5 feet.
5. Stake down the center every 5 feet.
6. Stake middles to create diamond pattern that provides stakes spaced 4-5 feet apart.
7. Use pointed 1x2 inch stakes 8-9 inches long. Leave 1-2 inch top above netting or use "U" shaped metal pins at least 9 inches long.
8. When joining 2 strips, overlap upper strip 3 feet over lower strip and secure with stakes every 2 feet like in "B" above.

# Burlap Bag Check Dams

Gravel-filled bags can be used to construct sediment barriers, diversions, and basins on slopes up to 25%.

Bags should be made of burlap material. Fill material can be coarse sand or gravel.

Place the bags in layers, with each layer overlapping the joints in the previous layer, and packed tightly. Fill the bags one-half full. Tie or fold down the top of the filled bag. If folded, place the bags with the folded top in the upstream or uphill direction, facing the flow of water. Limit placement to 2 layers high.

